



STAVANGER® –
smart solutions for every application

STAVANGER: A synonym for quality

Proven in practice and ideally equipped for the future – in many areas. Our STAVANGER® backpacks as well as bags have proven for many years to be of a high quality standard. Through continuous development and production in Europe our product series is unique, innovative and stable. In addition, it has been awarded various prizes.

Originally developed as an ideal alternative to the aluminum suitcase, the STAVANGER® backpack has since won over the most stubborn advocates with its robustness and its ability to work directly from the backpack, but with a suitcase layout.

Due to the most diverse requirements and areas of application, the STAVANGER® product series is constantly being expanded – so that you are always prepared for your assignment.



Table of contents

Backpack series XL	4
Backpack series C	20
Modules and accessories	32
Ampullarium	36
Pocket series E, V and D	40



STAVANGER XL series

The space miracle or saver – with many helpful refinements

The STAVANGER® XL series is the standard when it comes to emergency care. With the integrated magnet system, different sized storage modules can be placed in the backpack, maintaining the proven clarity and modularity. The large amount of space, the flexible container and system modules, the good overview and much more make the models an indispensable companion in everyday life.

- ✓ Easy cleaning thanks to the magnet system
- ✓ Ergonomically shaped shoulder straps with removable chest strap
- ✓ High quality 2-way zippers
- ✓ Winch loop for height rescue
- ✓ Various front pockets – depending on the model



STAVANGER XL series

IN DETAIL

Winch loop
for height rescue

Interchangeable
velcro® label for
individual labeling

Rubber loops for fastening

STAVANGER

Mesh pocket for
small items

Safety belt for
oxygen module

4 internal mesh compartments
with the possibility of individual
marking

Clear pocket with
magnetic closure

Stable floor glides

2-piece PVC
suitcase handle

Clear view pocket
for individual
labeling

Winch loop
for height rescue

Circumferential webbing
for stability

Proven magnet system
for hygienic cleaning



STAVANGER XL1000

The STAVANGER® XL1000 is our classic style. It impresses with an excellent overview and efficient space.

As soon as the backpack is opened, the self-assembling center panel and the clear arrangement of the modules reveal a high level of functionality. Thanks to the practical module openings, it is possible to work directly out of the backpack.

Even more comfortable and mobile is the STAVANGER® XLT1000 with integrated trolley frame!



STAVANGER® magnet system



Oxygen holder



Truck tarpaulin, original CORDURA®-fabric and 3M™ Scotchlite reflective-strips



Individual velcro®-backed label



W 43 x H 56 x D 26 cm
63 litres



3,9 kg



You can find more detailed information in our online store at www.fleischhacker.biz.



5828035

7717798



STAVANGER XL2000

The STAVANGER® XL2000 is ideally suited as a 2-backpack system. With integrated mounting points to hold oxygen, flexible module equipment, as well as the numerous pockets and holders in the lid compartment, this backpack offers you free rein for your creativity when it comes to material storage. For example, the blue XL2000 can be equipped for ventilation and the red XL2000 for circulatory emergencies. With the option of adding individual velcro®-backed signs which can be easily changed, the backpacks can be easily labeled for differentiation.



STAVANGER® magnet system



Oxygen holder



Truck tarpaulin, original CORDURA®-fabric and 3M™ Scotchlite reflective-strips



Individual velcro®-backed label



W 43 x H 56 x D 16 cm
39 litres



3.3 kg



You can find more detailed information in our online store at www.fleischhacker.biz.



Shoulder strap included



-  5828205
-  5828206
-  5828207



STAVANGER XL2100

The newest model in our XL Series is the STAVANGER® XL2100.

Those who find the XL1000 too large and the XL2000 too small will find this version to be the perfect size. In width and height, the XL2100 has identical dimensions, but lies exactly in the middle with a depth of 21 cm. Also includes 2 different height backpack halves.

Can be equipped individually according to your ideas with the help of the standard and system modules.



STAVANGER® magnet system



Oxygen holder



Truck tarpaulin, original CORDURA®-fabric and 3M™ Scotchlite reflective-strips



Individual velcro®-backed label



W 43 x H 56 x D 21 cm
51 litres



3.3 kg



You can find more detailed information in our online store at www.fleischhacker.biz.



Shoulder strap included



 7756390
 7757390

STAVANGER XL3000

The STAVANGER® XL3000 is a robust carrying backpack designed specifically for the needs of firefighters and police officers.

With its plastic-reinforced side walls - similar to those of a hard shell case - it is particularly stable and ideally suited for carrying heavy equipment, which could be used for opening doors. The tools version of the STAVANGER® XL3000 also comes with a customized foam insert.



STAVANGER® magnet system



Truck tarpaulin, original CORDURA®-fabric and 3M™ Scotchlite reflective-strips



Individual velcro®-backed label



W 43 x H 56 x D 21 cm
51 litres



Empty weight 4.2 kg



You can find more detailed information in our online store at www.fleischhacker.biz.



7700388

Shoulder strap included

tools-vary



STAVANGER XL4000

Identical in design to the XL2000, the STAVANGER® XL4000 also comes with a front compartment. The advantage is obvious: quick access to emergency equipment, such as all common AED models, or alternatively to the XL container and system modules, such as the ampoule kit. The clear-view front pocket with variable interior partitioning allows the contents to be seen. Also includes a compartment for immobilization collars or documents, which fits almost invisibly between the front and the inner body.



STAVANGER® magnet system



Oxygen holder



Truck tarpaulin, original CORDURA®-fabric and 3M™ Scotchlite reflective-strips



Individual velcro®-backed label



W 43 x H 56 x D 28 cm
54 litres



3.9 kg



You can find more detailed information in our online store at www.fleischhacker.biz.



Shoulder strap included



-  5828052
-  5828061
-  5828064



STAVANGER XL5000

With its 77 liters, the XL5000 has the largest storage space of our STAVANGER® backpack models. So there's room for everything you need.

The lower front compartment equipped with the magnet system can be fitted with our standard and system modules up to size XL, our system plate or an AED. The upper front compartment can hold small diagnostic equipment, including the rescue scissors with a holder designed for this purpose.



STAVANGER® magnet system



Oxygen holder



Truck tarpaulin, original CORDURA®-fabric and 3M™ Scotchlite reflective-strips



Individual velcro®-backed label



W 43 x H 56 x D 32 cm
77 litres



4.6 kg



You can find more detailed information in our online store at www.fleischhacker.biz.



5828053

5828058



STAVANGER C series

The compacts - for special applications

Compared to the XL backpack series, the STAVANGER® C series has been developed with a special focus on use in specific situations. While the award-winning STAVANGER® C1000 and the C2000 function as compact all-rounders, the STAVANGER® C3000 has found its place in oxygen supply. Equipped with the integrated magnet system, different sized storage modules can be placed in the backpack in a way that maintains clarity and modularity.

- ✓ Ergonomically shaped shoulder straps with removable chest and waist straps
- ✓ High quality 2-way zippers
- ✓ Winch loop for height rescue
- ✓ Easy cleaning thanks to the magnet system



STAVANGER C1000

IN DETAIL



Winch loop
for height rescue

4 internal mesh compartments
with the possibility of individual
marking

Clear pocket with
magnetic closure

Interchangeable velcro®
label for individual
labeling

Rubber loops
for fastening

Mesh pocket for
small items

Safety belt for
oxygen module

Stable floor glides

2-piece PVC
suitcase handle

Clear view pocket
for individual
labeling

Circumferential webbing
for stability

Proven magnet system
for hygienic cleaning



STAVANGER C1000

The C1000 is the little brother of the STAVANGER® XL1000.

The compact design of the C1000, with a completely adjustable center panel makes the Red Dot winner from 2019 one of our most popular backpack models. The C1000 offers sufficient space for emergency materials. For example, up to a 2-litre oxygen cylinder.

Even more comfortable and mobile is the STAVANGER® CT1000 with integrated trolley frame!



STAVANGER® magnet system



Oxygen holder



Truck tarpaulin, original CORDURA®-fabric and 3M™ Scotchlite reflective-strips



Individual velcro®-backed label



W 39 x H 46 x D 24 cm
43 litres



3.1 kg



You can find more detailed information in our online store at www.fleischhacker.biz.



reddot award 2019
winner

5828070
5828069

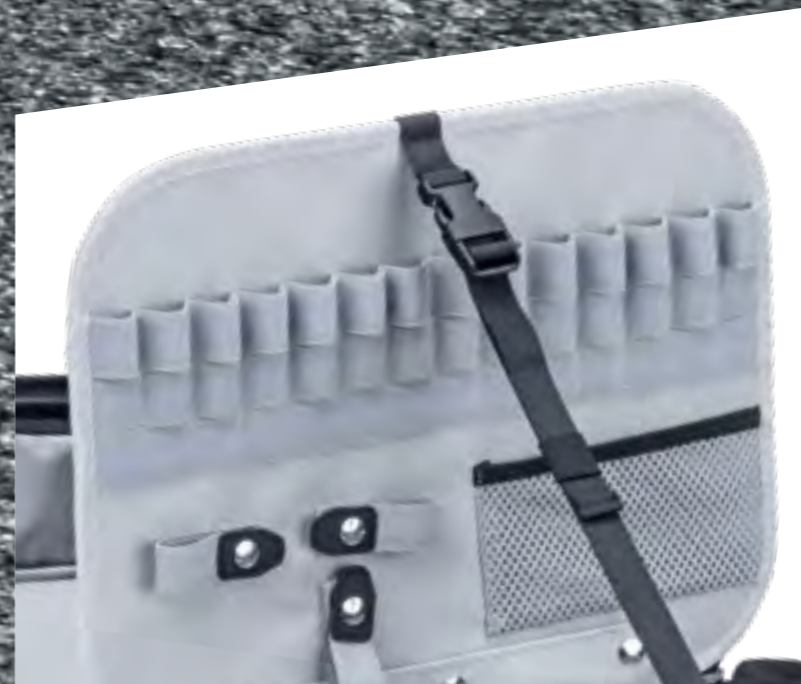

STAVANGER C2000

Despite its compact dimensions, our STAVANGER® C2000 impresses with a large amount of space inside. With its ideal size it is quickly at hand, both for the doctor and the first aider on site. The right side, equipped with a magnet system, can be fitted with our modules. The left side has 2 fixed compartments with 2-way zips, e.g. for holding an AED. As with many other models, the STAVANGER® C2000 is also available already filled: e.g. with the GP type for internal medicine emergencies or the school first aid type for easier first aid.



STAVANGER® magnet system



Truck tarpaulin, original CORDURA®-fabric and 3M™ Scotchlite reflective-strips



Individual velcro®-backed label



W 28 x H 50 x D 15 cm
21 litres



2.3 kg



You can find more detailed information in our online store at www.fleischhacker.biz.



5828066

5828067



Shoulder strap included



STAVANGER C3000

The STAVANGER® C3000 is a compact oxygen backpack for O₂ cylinders up to 2 liters.

In the lid there is a foil pocket that can be closed with a 2-way zipper for storing necessary ventilation accessories. The proven 2-handle design and the shoulder strap included enable comfortable carrying.

The STAVANGER® C3000 is also designed for oxygen supply during transport.



STAVANGER® magnet system



Oxygen holder



Truck tarpaulin, original CORDURA®-fabric and 3M™ Scotchlite reflective-strips



Individual velcro®-backed label



W 28 x H 51 x D 16 cm
23 litres



2.2 kg



You can find more detailed information in our online store at www.fleischhacker.biz.



5828009



Shoulder strap included



STAVANGER MAGNETSYSTEM

Want to assemble your backpack, but not sure if everything fits?

The dots indicate the position of the magnets, which ultimately determines the modular assembly. In principle, the module sizes are quite simple.

- 1 x XL module = 2 x L module
- 1 x L module = 2 x M module
- 1 x MM module = 2 x M module

A higher magnetization is required for the oxygen holder. Hence the reinforcement with the green marked dots, which can always be found in the left backpack tray.

We would be happy to work with you to put together the right equipment of magnetic modules for your individual application. Our specialist staff is not only available to advise you in an individual online live presentation, but can also visit and advise you on site with our mobile showroom „STAVANGER on Tour“.

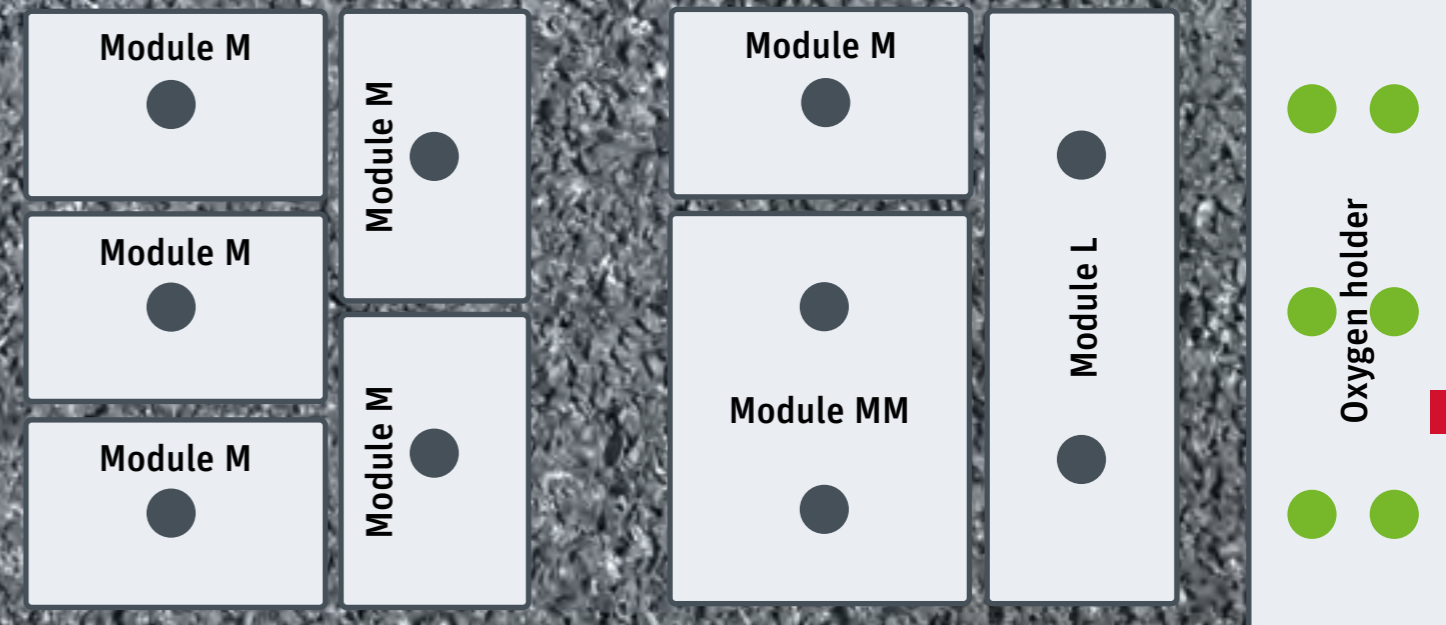
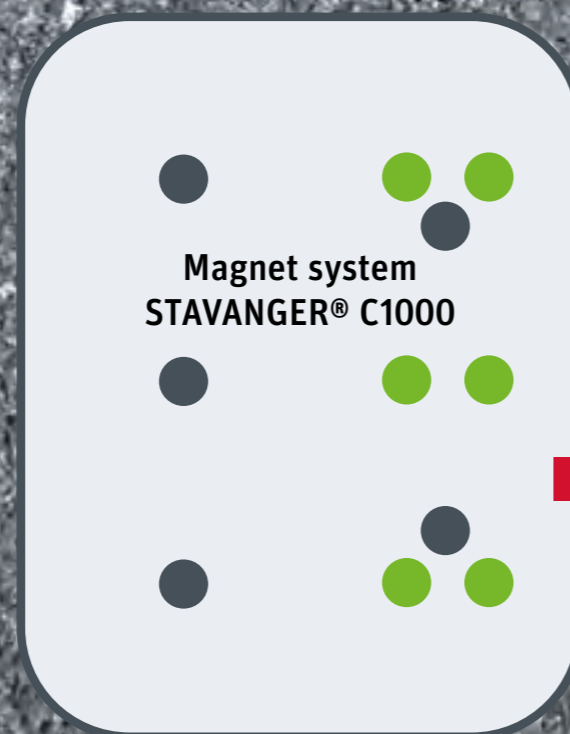
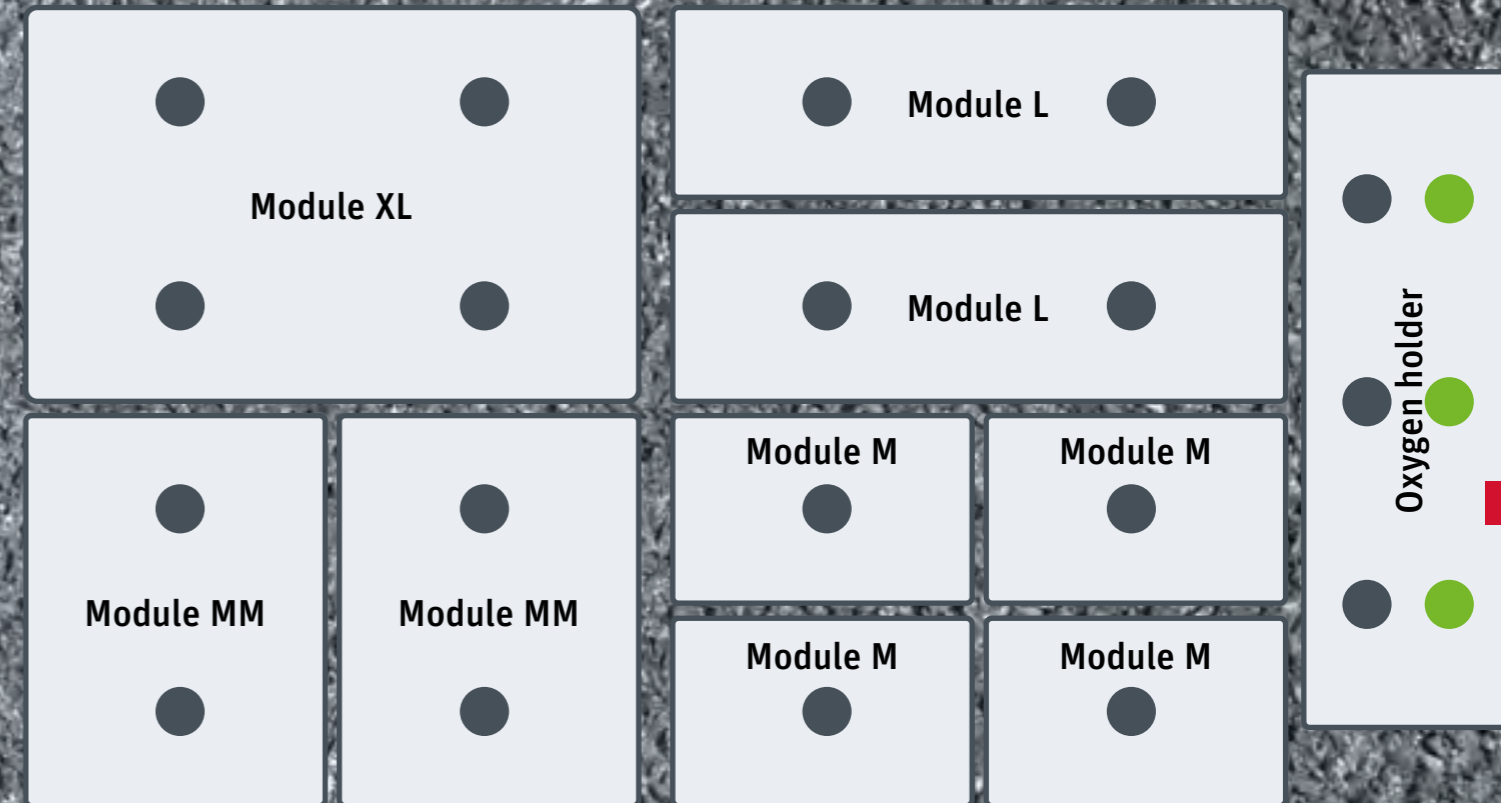
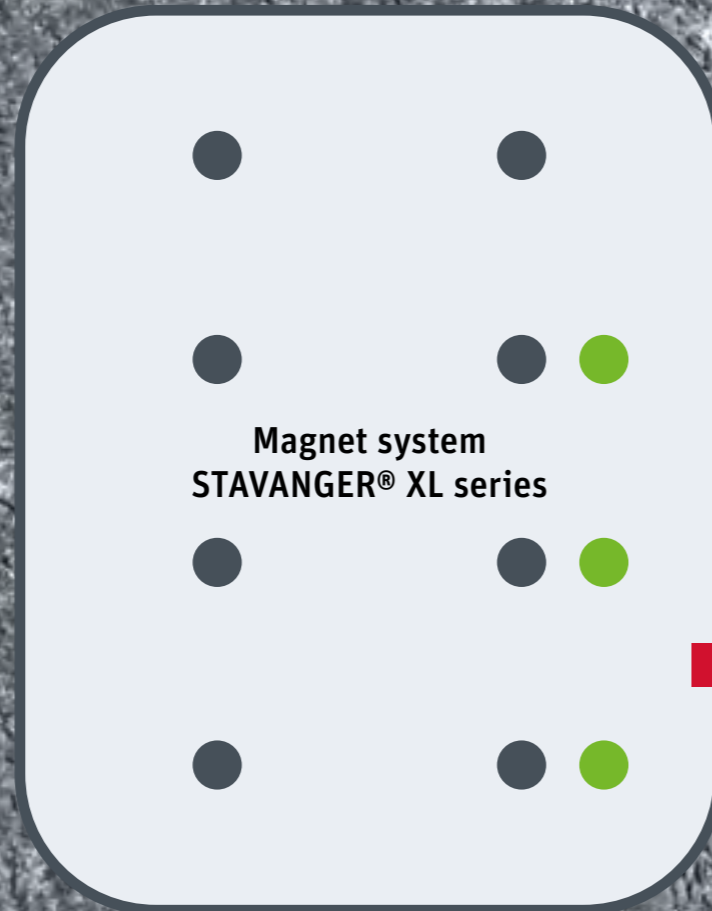

MODULES & ACCESSORIES

Labeling set
7180639



For labeling container modules with intubation, ventilation, suction, wound care, diagnostics, injection, infusion, medications, dressings, accessories and first aid.

Velcro®-backed label
5828004



For individual labeling of STAVANGER® backpacks or bags.

Foil insert

Type A 7729159 | Type B 7729161



The foil inserts are suitable for dividing very small materials such as syringes and cannulas in container modules. The low overall height of 4 cm is especially designed for use in the container module LF light, but is also suitable for many other container modules of the STAVANGER® family.

Container modules

Size LS 7330138 | Size XL 5828037 | Size L 5828038 |
Size MM 5828062 | Size M 5828039



Size LS 36 x 6.5 x 10 cm Size XL 36 x 25 x 10 cm Size L 36 x 13 x 10 cm
Size MM 18 x 24 x 10 cm Size M 18 x 13 x 10 cm

The container modules made of robust truck tarpaulin with practical viewing window facilitate the organization of all materials in STAVANGER® backpacks or bags. The 2-way zipper system allows quick removal in case of emergency.

Container modules: light

Size XL 5828089 | Size L 5828088 | Size MM 5828087 |
Size M 5828086 | Size LF 7729156 | Size MMF 7756391 |
Size MF 7756393

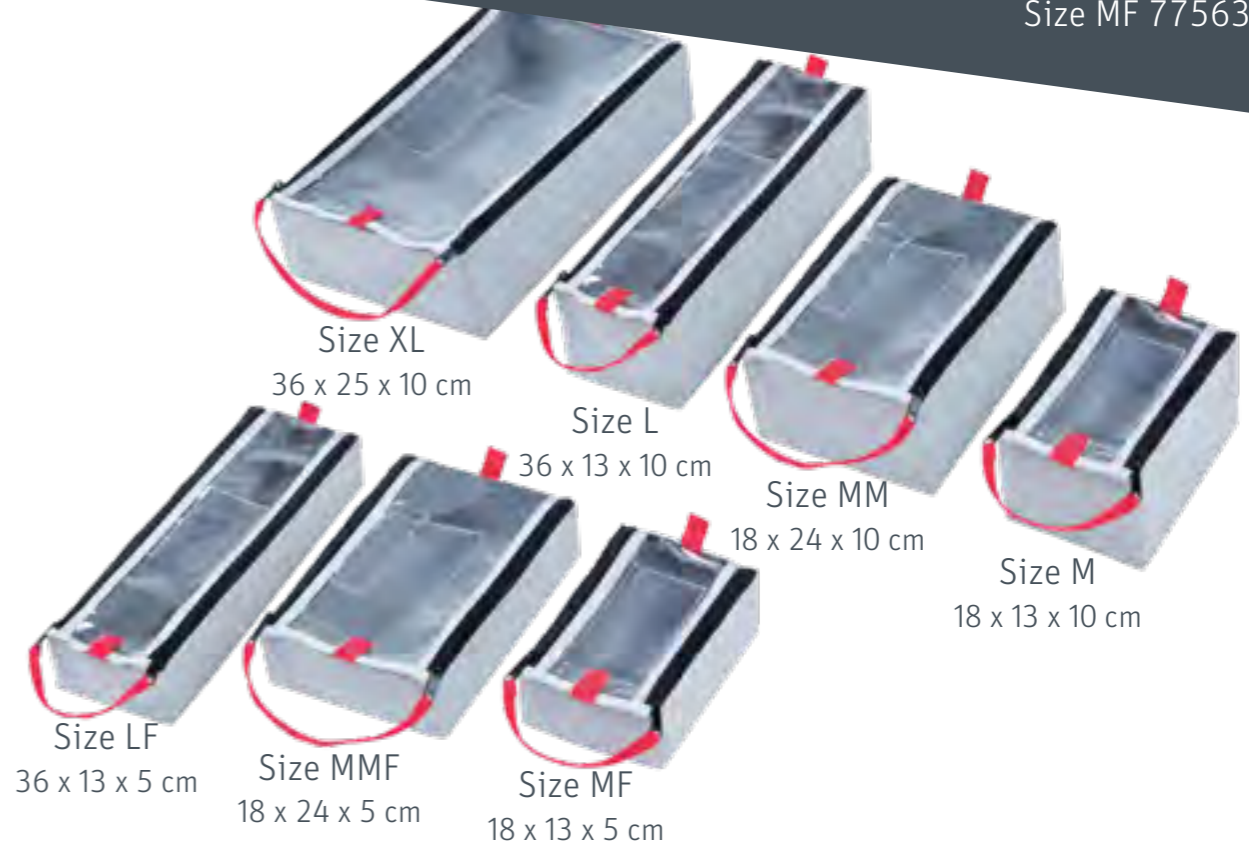

Size XL 36 x 25 x 10 cm Size L 36 x 13 x 10 cm Size MM 18 x 24 x 10 cm Size M 18 x 13 x 10 cm
Size LF 36 x 13 x 5 cm Size MMF 18 x 24 x 5 cm Size MF 18 x 13 x 5 cm

These container modules, which have been weight-optimized by approx. 40%, enable the total weight to be minimized by up to 1,000 g.

MODULES & ACCESSORIES

System modules

Size XM 7729147 | Size MM 7728573 | Size XL 7729137



The system modules can be used for a wide variety of applications. Designed for use as an ampoule box, all outer walls are fitted with a thermal liner so that the medications can be kept within the recommended temperature range.



Oxygen holder
5828034



Oxygen holder with plug-in lock for 0.8-liter to 2-liter cylinders.

McGrath Module insert
5828091



The foam insert provides secure support for a McGRATH® videolaryngoscope. Suitable for container module size MM.

ENDO Module insert
7756616



For the ideal overview of the different sized endotracheal tubes. Suitable for container module size XL.

EZ-IO Module insert
7726383



Secures the upright hold of the EZ-IO drill to the short side wall. Suitable for container module size M.

Module insert access
7704364



Secures the EZ-IO drill and has additional holders for other items such as ampoules. Suitable for container module size MM.

STAVANGER AMPOULE KIT

Our STAVANGER® ampoule systems inspire with their clear arrangement and organization of medications and other materials. The unique, self-developed retaining clips secure the sensitive glass ampoules and guarantee quick removal in an emergency. The clips can be arranged lengthwise or crosswise to make the best use of space, storing many ampoules has never been easier and with the help of labeling clips, refilling is child's play.



reddot winner 2021



STAVANGER® magnet system



Truck tarpaulin



Size XM: W 18 x H 5 x D 13 cm
Size MM: W 24 x H 12 x D 18 cm
Size XL: B 36 x H 12 x D 25 cm



Also available in practically assembled sets.



You can find more detailed information in our online store at www.fleischhacker.biz.

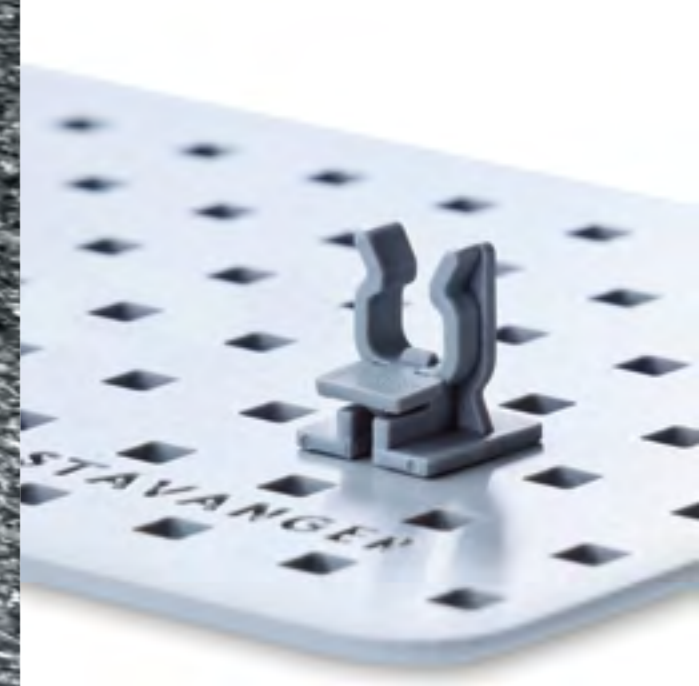

STAVANGER AMPOULE KIT

System plate Connect

Size XXL 7731473 | Size XL 7731475 | Size L 7731476 |
Size MM 7731477 | Size XM 7731479

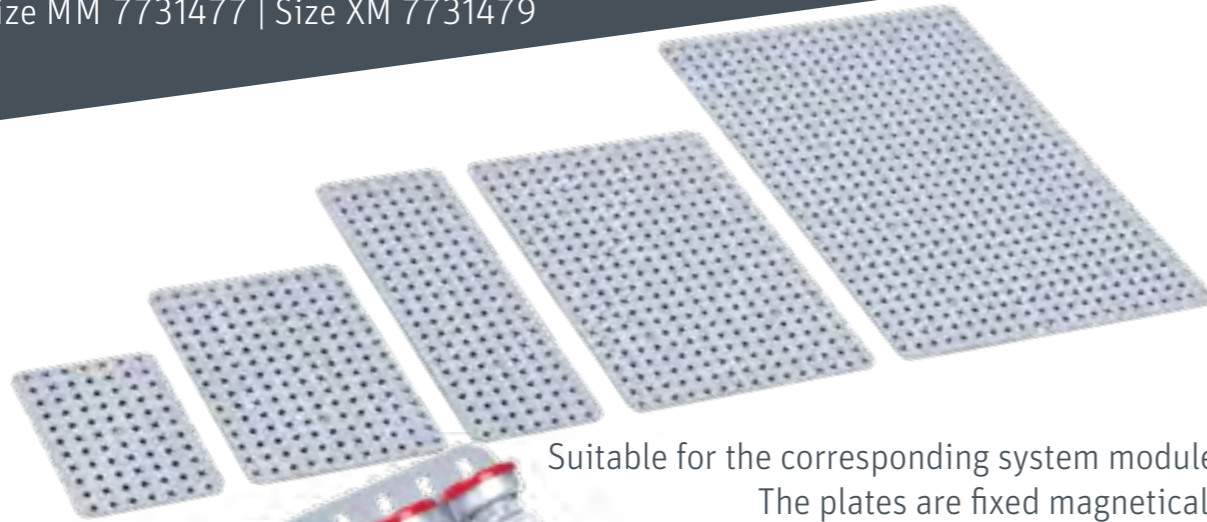

Suitable for the corresponding system modules.
The plates are fixed magnetically.



Retaining clip (20 pieces) 7729134



Serves to fix all common glass ampoules
from 1 ml to 10 ml.

Locking pegs (20 pieces) 7729136

For secure fixing of a spacer
or retaining clip.

Labeling clip (20 pieces) 7729138

Enables clean and uniform labeling of
ampoule slots.

Distance clip (20 pieces) 7729140

Ensures sufficient distance between the
center wall and the base plate.

Book screw (20 pieces) 7734716

For fixing the center panel, foil pockets
or LoopFlex rubber bands.

Sticker set (active ingredient) 7729141

For center wall mounting,
suitable for system module MM.

SingleFlex (10 pieces)

35 mm 7714266 | 55 mm 7714265 |
100 mm 7714264



Enables the fixation of light and different
sized materials on the system plate.

LoopFlex

50 mm 7729142 | 80 mm 7729154 |
110 mm 7729155 | 150 mm 7729157 |
200 mm 7729160



Allows heavier materials to be fixed to
the system plate.

Foil bags

S 7727609 | M 7727610 | L 7727611 |
XL 7727613 | SF 7727615 |
MF 7727616 | LF 7727619 |
XLF 7727620



Enables different sized materials to be
accommodated on the system plate.

STAVANGER E-, V- & D series

Our bags – for all applications

Those who prefer to work with bags instead of backpacks will certainly find the right one in our various bag series. The E-series insert bags impress with the many firmly processed compartments. All materials find their place there. The variable models of the V-series leave nothing to be desired in terms of flexibility. From the classic design of the doctor's bag to the special bag for trauma care. The cleverly designed document cases of the D-Series complement the STAVANGER® range.

- ✓ Variable use of STAVANGER® pockets
- ✓ High quality materials for long lasting use
- ✓ Various bag sizes
- ✓ Strong design with many colors
- ✓ Well thought-out concepts for the organization of your materials



STAVANGER E3000

The compact format of the highly stable STAVANGER® E3000 emergency bag allows it to always be at hand. The flexibly divisible interior offers enough storage space for important emergency equipment. And for those who like it more handy: our container modules M and MM also fit inside. The 3M Scotchlite reflective strips on the sides ensure maximum safety at the scene of an accident and on the way there.

On the back is an exterior compartment with top and bottom zipper for documents or trolley attachment. Various mesh pockets and rubber loops provide flexible material storage.

Shoulder strap included



Truck tarpaulin and 3M™ Scotchlite reflective-strips



W 37 x H 25 x D 26 cm
24 litres



2.2 kg



You can find more detailed information in our online store at www.fleischhacker.biz.



5828054



STAVANGER E4000

The STAVANGER® E4000 emergency bag is a real all-rounder for holding many materials thanks to the numerous integrated compartments, such as the external side pockets and the fold-out system pockets on the inside. So you can easily keep things in order. The flexibly divisible interior offers enough storage space for important equipment that is needed in an emergency. And for those who like it more handy: our container modules M, MM and L also fit inside. The 3M™ Scotchlite reflective strips on the sides ensure maximum safety at the scene of an accident and on the way there.



Shoulder strap included



5828055



Truck tarpaulin and 3M™ Scotchlite reflective-strips



W 54 x H 31 x D 33 cm
46 litres



3.7 kg



You can find more detailed information in our online store at www.fleischhacker.biz.



STAVANGER V1000

Our STAVANGER® V1000 is the ideal companion for mobile use and was developed in cooperation with doctors and midwives. Even more compact, even more flexible and more handy - and still no loss of storage space or efficiency .

With the removable padded shoulder strap, adjustable in length on both sides, the V1000 can be easily shouldered or carried in the hand with the rubberized handle. The bag not only offers enough space for your equipment, but also ensures a perfect overview of all equipment thanks to the intelligent interior. Also available with the STAVANGER® D2000 model (see p. 58) offering you the perfect tool to organise your notes.



Shoulder strap included



Truck tarpaulin and 3M™ Scotchlite reflective-strips



W 50 x H 32 x D 26 cm
42 litres



3.5 kg



You can find more detailed information in our online store at www.fleischhacker.biz.



5828080

STAVANGER V2000

The STAVANGER® V2000 is our MANV bag and was designed to fit perfectly in compartment 21, according to the uniform state standard for ambulances in Rhineland-Palatinate 2018. The current danger situation as well as the potential increase in offenses involving armed violence mean that additional equipment for tactical emergencies is becoming increasingly important alongside standardized first aid equipment.

Various rubber loops and a large clear pocket provide enough space to hold equipment for a mass casualty incident. The clear insert pocket located in the lid of the bag can hold the documents necessary for triaging. On the back side, an optionally available clipboard finds space in the slide-in compartment.

Shoulder strap included



Truck tarpaulin and 3M™ Scotchlite reflective-strips



W 40 x H 8 x D 25 cm
8 litres



0.9 kg



You can find more detailed information in our online store at www.fleischhacker.biz.



7321301

STAVANGER V3000

The STAVANGER® V3000 is our TRAUMA bag and was designed to fit compartment 21, according to the state standard for ambulances in Rheinland-Pfalz 2018. Among other things, the bag offers sufficient space for use with trauma patients. In addition, immobilization collars, pelvic slings and universal splints can also be stowed in the interior. The large foil compartment is used to hold additional equipment. The lid has been equipped with 7 practical rubber loops for small items such as skin disinfectants, instruments, ligation systems and emergency bandages, as well as a further transparent compartment.



7321300
5828097

Shoulder strap included



Truck tarpaulin, original CORDURA®-fabric and 3M™ Scotchlite reflective-strips



W 46 x H 22 x D 25 cm
25 litres



1.1 kg



You can find more detailed information in our online store at www.fleischhacker.biz.



STAVANGER V4000

The STAVANGER® V4000 is a real all-rounder because it can be equipped in any number of combinations - true to our proven modular principle. It can be equipped with magnetically held modules as well as with system plates. These can be used with the help of our various retaining clips, SingleFlex and LoopFlex straps to hold a wide variety of materials: whether glass and lancet ampoules, materials for wound care, diagnostic equipment, instruments or something else entirely. Even 8 container modules LF light can be accommodated. It could hardly be more flexible.



STAVANGER® magnet system



Truck tarpaulin, original CORDURA®-fabric and 3M™ Scotchlite reflective-strips



Individual velcro®-backed label



W 52 x H 37 x D 12 cm
23 litres



2.8 kg



You can find more detailed information in our online store at www.fleischhacker.biz.

-  7729135
-  7729210
-  7737421



Shoulder strap included



STAVANGER V6000

Those who find the V3000 too small might do better with the STAVANGER® V6000. This is because its format makes it ideal for accommodating immobilization collars. To organize the additional materials that need to be stowed, both sides are equipped with compartments with clear covers. Thus, when the bag is opened, the materials remain in place and are easily accessible thanks to the 2-way zipper.



Shoulder strap included



Truck tarpaulin, original CORDURA®-fabric and 3M™ Scotchlite reflective-strips



Individual velcro®-backed label



W 85 x H 27 x D 18 cm
41 litres



3.4 kg



You can find more detailed information in our online store at www.fleischhacker.biz.



7714013

STAVANGER D1000

The STAVANGER® D1000 document bag is ideally suited for the operations manager, group or squad leader. It brings clarity and order to the hectic workday. High-quality workmanship and sophisticated design in the already well-known STAVANGER® quality.

Inside you'll find a 2-ring binder for your preprints and various interior slip and pen pockets. The protective center divider has 2 foil pockets with Velcro closures and a large, clear pocket for a tablet. In addition to the comfortable carry handle, a shoulder strap is included. There is also room to add a clipboard in the designated slip-in compartment on the back.

-  5828056
-  5828057
-  5828005



Shoulder strap included



Truck tarpaulin, original CORDURA®-fabric and 3M™ Scotchlite reflective-strips



W 39 x H 29 x D 8 cm
9 litres



1.5 kg



You can find more detailed information in our online store at www.fleischhacker.biz.

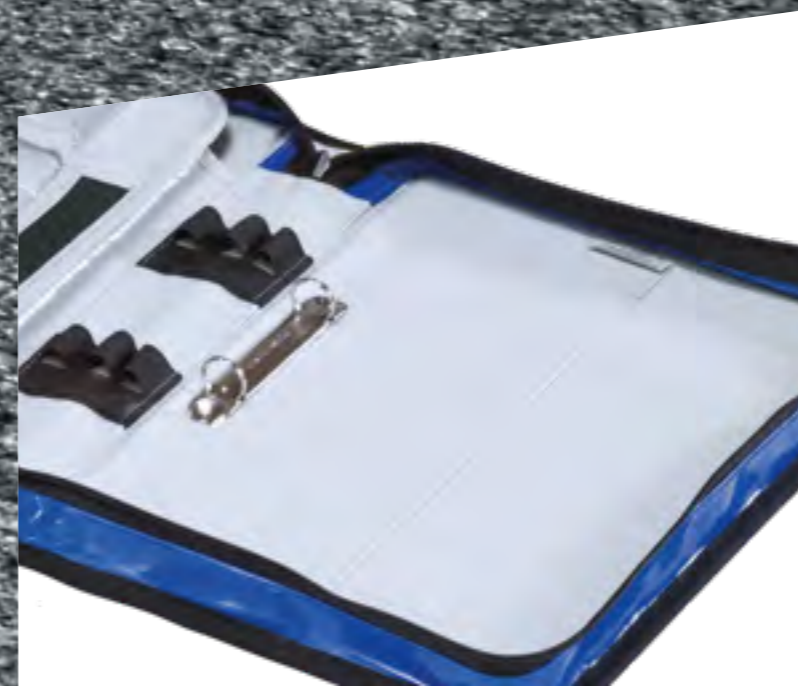

STAVANGER D2000

The STAVANGER® D2000 document folder gives you plenty of storage space. The three-sided, 2-way zipper guarantees quick opening even in the most stressful situations.

The intelligent interior not only gives you a perfect overview, it also allows you to store index cards, receipts, forms, business cards and a tablet.

By the way: The document folder is not only an absolute eye-catcher on its own, it also fits perfectly into the side pocket of the STAVANGER® V1000 due to its dimensions.

 5828082



Truck tarpaulin and original CORDURA®-fabric



W 23 x H 29 x D 5 cm
3 litres



0.8 kg



You can find more detailed information in our online store at www.fleischhacker.biz.





STAVANGER

Fleischhacker GmbH & Co. KG
An der Silberkuhle 18
58239 Schwerte

T +49 (0) 2304 931-0
F +49 (0) 2304 931-212

stavanger@fleischhacker.biz
www.fleischhacker.biz